

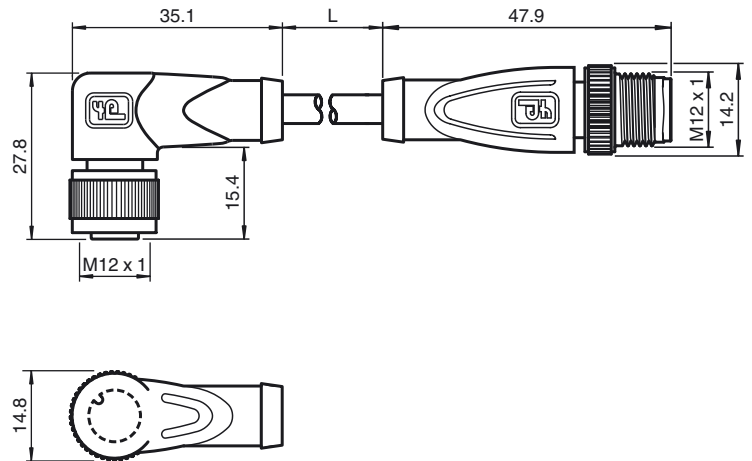

Dimensions



Model Number

V1-W-2M-PUR-V1-G

Connection cable, M12 to M12, PUR cable, 4-pin

Features

- Knurled nut suitable for tool assembly
- Immunity to vibration, with mechanical latching
- Degree of protection IP67 / IP68 / IP69K
- Halogen-free
- Gold plated contacts

Technical data

General specifications

Number of pins 4

Electrical specifications

Operating voltage U_B max. 250 V AC/DC
 Operating current I_B max. 4 A
 Contact resistance < 10 mΩ

Ambient conditions

Ambient temperature -25 ... 100 °C (-13 ... 212 °F)
 for temperatures over 80 °C (176 °F) reduced elongation at tear
 Pollution degree 3

Mechanical specifications

Contact elements spring-loaded contact socket
 Pin diameter 1 mm
 Degree of protection IP67 / IP68 / IP69k

Material

Contacts CuSn / Au
 Contact surface Au
 Body TPU, black
 Cable PUR
 Slotted nut Diecast zinc
 Sleeve connector Diecast zinc
 Core insulation PP
 Cable fine-strand, flexible
 Sheath diameter Ø 4.8 mm
 Bending radius > 10 x cable diameter, moving
 Color grey
 Number of cores 4
 Core cross-section 0.34 mm²
 Conductor construction 19 x 0.15 mm Ø
 Length L 2 m

Flammability

Contact carrier 94 HB
 Housing 94 V-2

Compliance with standards and directives

Standard conformity
 Degree of protection EN 60529:2000
 Standards IEC 61076-2-101:2008

Electrical connection

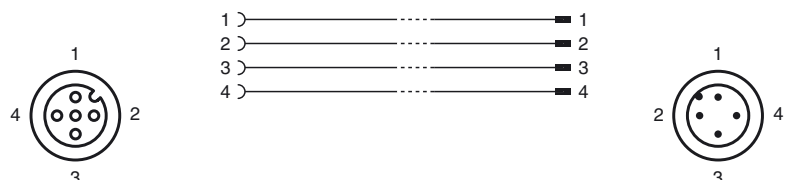

Release date: 2016-01-18 08:51 Date of issue: 2016-01-18 098854_eng.xml