

# WORLD-BEAM QS18



Miniature self-contained photoelectric sensors in universal housing



- Easily fits (or retrofits) almost any mounting situation
- Exceptional optical performance, comparable to larger “MINI-style” or barrel sensors
- 10 to 30V dc operation, with complementary (SPDT) NPN or PNP outputs, depending on model
- Bright LED operating status indicators are visible from 360°
- Rugged sealed housing, protected circuitry
- Models available with or without 18 mm threaded “nose”
- Less than 1 millisecond output response for excellent sensing repeatability
- Choose 2 m (6.5 ft) or 9 m (30 ft) cable or 150 mm (6 inch) Pico-style pigtail QD

Opposed Mode	Model <sup>1</sup>	Range	Output
Effective beam: 13 mm (0.5 inch) 	QS186EV (624 nm Visible Red)	20 m (66 ft)	N/A
	QS186E (940 nm Infrared)		N/A
	QS18VN6R		NPN
	QS18VP6R		PNP
Effective beam: 13 mm (0.5 inch) 	QS186EB (940 nm Infrared)	3 m (10 ft)	N/A
	QS18VN6RB		NPN
	QS18VP6RB		PNP
Polarized Retroreflective Mode	Model <sup>1</sup>	Range	Output
630 nm Visible Red 	QS18VN6LP	3.5 m (12 ft)	NPN
	QS18VP6LP		PNP
Retroreflective Mode	Model <sup>1</sup>	Range	Output
628 nm Visible Red 	QS18VN6LV	6.5 m (21 ft)	NPN
	QS18VP6LV		PNP
Convergent Mode	Model <sup>1</sup>	Range	Output
630 nm Visible Red 	QS18VN6CV15	16 mm (0.63 ft)	NPN
	QS18VP6CV15		PNP
	QS18VN6CV45	43 mm (1.7 inches)	NPN
	QS18VP6CV45		PNP

<sup>1</sup> Standard 2 m (6.5 ft) cable models are listed. To order the 9 m (30 ft) cable model, add suffix "W/30" to the cabled model number.

**QD Models.** For 4-pin integral Euro-style QD, add suffix “Q8” (e.g., QS186EQ8). For 4-pin integral Pico-style QD, add suffix “Q7” (e.g., QS186EQ7). For 4-pin 150 mm (6”) Euro-style pigtail, add suffix “Q5” (e.g., QS186EQ5). For 4-pin 150 mm (6”) Pico-style pigtail, add suffix “Q” (e.g., QS186EQ).

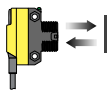
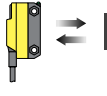
Diffuse Mode	Model <sup>1</sup>	Range	Output
940 nm Infrared 	QS18VN6D	450 mm (18 inches)	NPN
	QS18VP6D		PNP
	QS18VN6DB (Diffuse, wide)		NPN
	QS18VP6DB (Diffuse, wide)		PNP

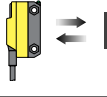
Divergent Mode	Model <sup>1</sup>	Range	Output
940 nm Infrared 	QS18VN6W	100 mm (4 inches)	NPN
	QS18VP6W		PNP

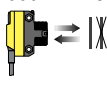
Fixed Field Mode	Model <sup>1</sup>	Range	Output
660 nm Visible Red 	QS18VN6FF50	50 mm (2 inches)	NPN
	QS18VP6FF50		PNP
	QS18VN6FF100	100 mm (4 inches)	NPN
	QS18VP6FF100		PNP

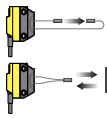
Plastic Fiber Optic Mode	Model <sup>1</sup>	Range	Output
660 nm Visible Red 	QS18VN6FP	Range varies by sensing mode and fiber optics used	NPN
	QS18VP6FP		PNP

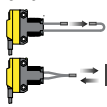
Glass Fiber Optic Mode	Model <sup>1</sup>	Range	Output
940 nm Infrared 	QS18VN6F	Range varies by sensing mode and fiber optics used	NPN
	QS18VP6F		PNP

<sup>1</sup> Standard 2 m (6.5 ft) cable models are listed. To order the 9 m (30 ft) cable model, add suffix "W/30" to the cabled model number.

**QD Models.** For 4-pin integral Euro-style QD, add suffix "Q8" (e.g., QS186EQ8). For 4-pin integral Pico-style QD, add suffix "Q7" (e.g., QS186EQ7). For 4-pin 150 mm (6") Euro-style pigtail, add suffix "Q5" (e.g., QS186EQ5). For 4-pin 150 mm (6") Pico-style pigtail, add suffix "Q" (e.g., QS186EQ).



**WARNING: Not To Be Used for Personnel Protection**  
**Never use this device as a sensing device for personnel protection. Doing so could lead to serious injury or death.** This device does not include the self-checking redundant circuitry necessary to allow its use in personnel safety applications. A sensor failure or malfunction can cause either an energized or de-energized sensor output condition.

## Specifications

### Supply Voltage

10 to 30V dc (10% maximum ripple) at less than 25 mA, exclusive of load;  
Protected against reverse polarity and transient voltages

### Repeatability

Opposed Mode: 100 microseconds  
FF Mode: 160 microseconds  
All others: 150 microseconds

### Adjustments

Glass Fiber Optic, Plastic Fiber Optic, Convergent, Difuse, and Retroreflective mode models (only): Single-turn sensitivity (Gain) adjustment potentiometer

### Indicators

**2 LED indicators on sensor top:**

**Green ON steady:** Power ON

**Yellow ON steady:** Light sensed

**Green flashing:** Output overloaded

**Yellow flashing:** Marginal excess gain (1 to 1.5x excess gain)

Prior to date code 0223, the output indicator was red.

### Construction

ABS housing  
3 mm mounting hardware included

### Connections

2 m (6.5 ft) 4-wire PVC cable, 9 m (30 ft) 4-wire PVC cable, 4-pin Pico-style or Euro-style QD, 4-pin Pico-style or Euro-style 150 mm (6 in) pigtail QD, depending on model

### Output Configuration

Solid-state complementary (SPDT): NPN or PNP (current sinking or sourcing), depending on model;

**Rating:** 100 mA maximum each output at 25°C

Off-state Leakage Current (FF Mode): less than 200 µA @ 30V dc

Off-state Leakage Current (All others): less than 50 µA @ 30V dc

ON-state Saturation Voltage: less than 1V @ 10 mA;  
less than 1.5V @ 100 mA

Protected against false pulse on power-up and continuous overload or short circuit of outputs

### Output Response

Opposed Mode: 750 microseconds ON; 375 microseconds OFF

FF Mode: 850 microseconds ON/OFF

All others: 600 microseconds ON/OFF

NOTE: 100 millisecond delay on power-up; outputs do not conduct during this time

### Environmental

Rated IEC IP67; NEMA 6

### Operating Conditions

Temperature: -20 to +70 °C (-4 to +158 °F)

Relative Humidity: 90% @ 50° C (non-condensing)

### Certifications



# Dimensions and Features

## Models E, EV, R, and FF

## Models EB and RB

## Models DB and W

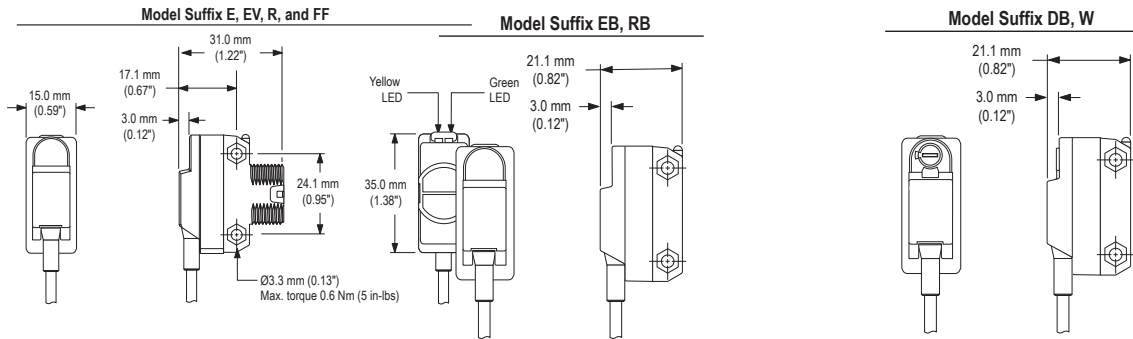

## Models FP

## Models CV15, CV45, D, LV, and LP

## Models F

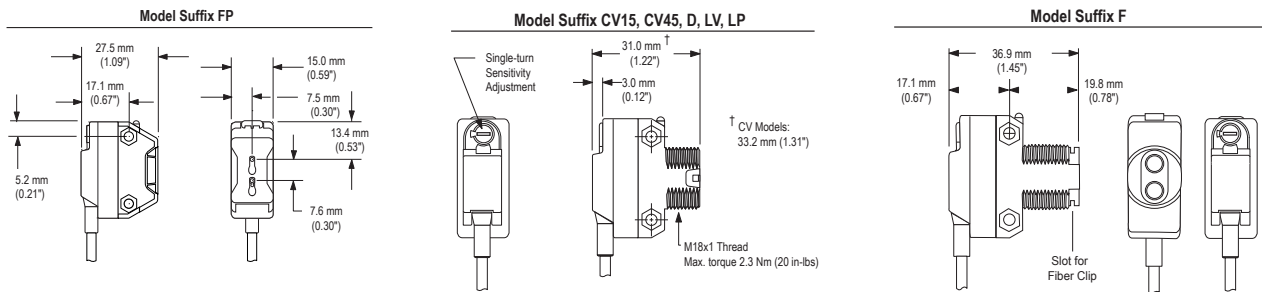

### Model Suffix Q (e.g. QS186EQ)

### Model Suffix Q5 (e.g. QS186EQ5)

### Model Suffix Q7 (e.g. QS186EQ7)

### Model Suffix Q8 (e.g. QS186EQ8)

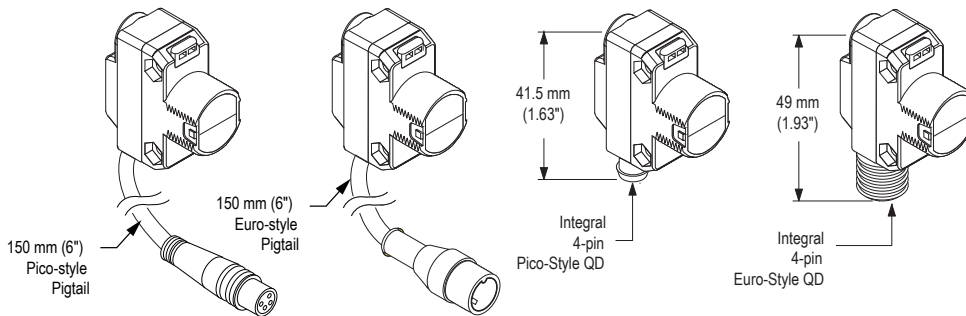

## M18 x 1 Jam Nut

## Packing List

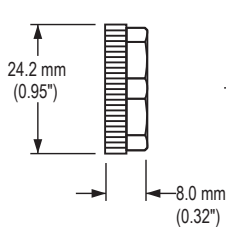

M3 hardware packet contents:  
 2 - M3 x 0.5 x 20 mm stainless steel screw  
 2 - M3 x 0.5 stainless steel hex nut  
 2 - M3 stainless steel washer

Sensor  
 M18 x 1 jam nut  
 M3 hardware packet  
 Installation sheet, p/n 63687

# Performance Curves

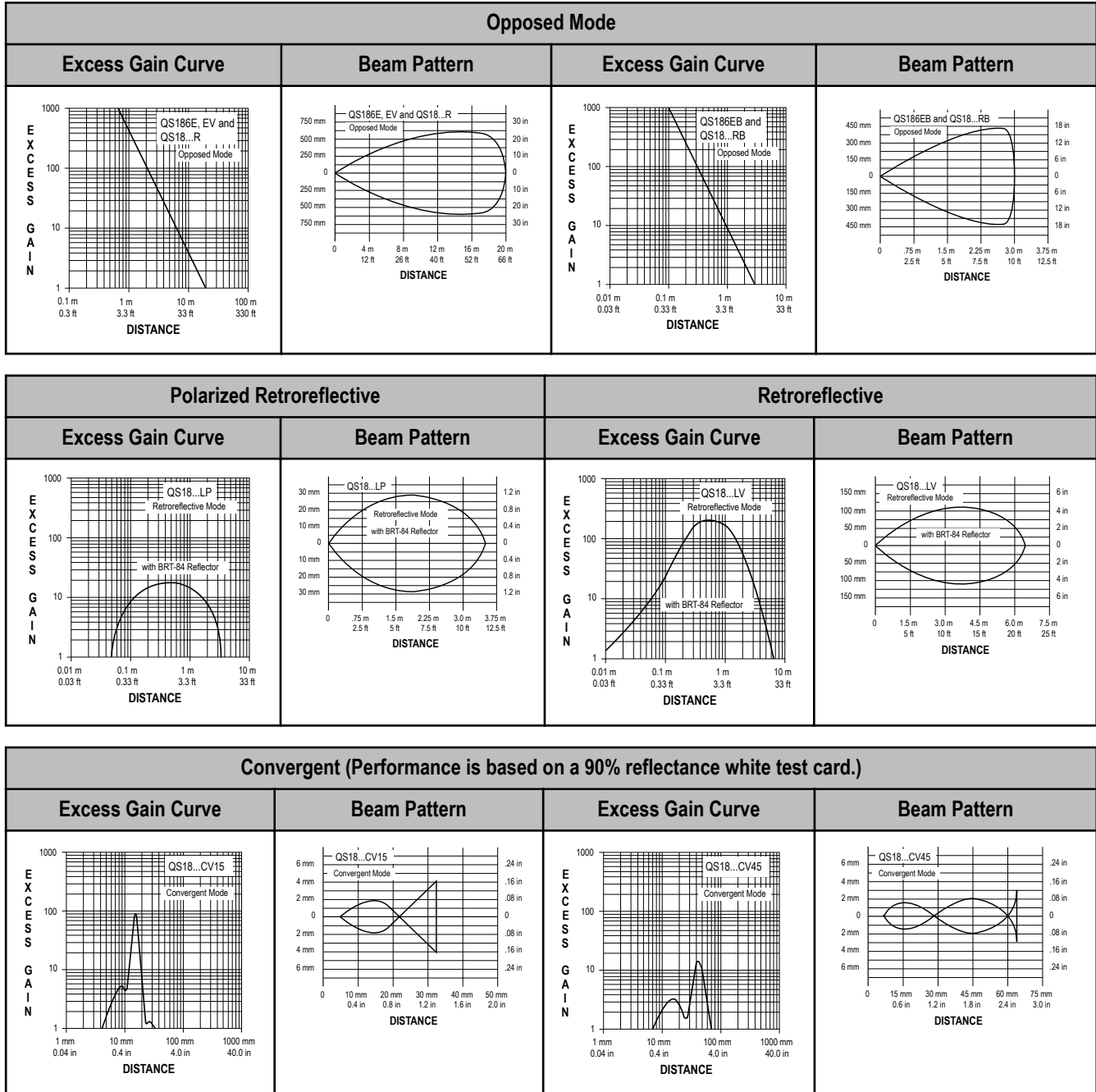

**Diffuse (Performance is based on a 90% reflectance white test card.)**

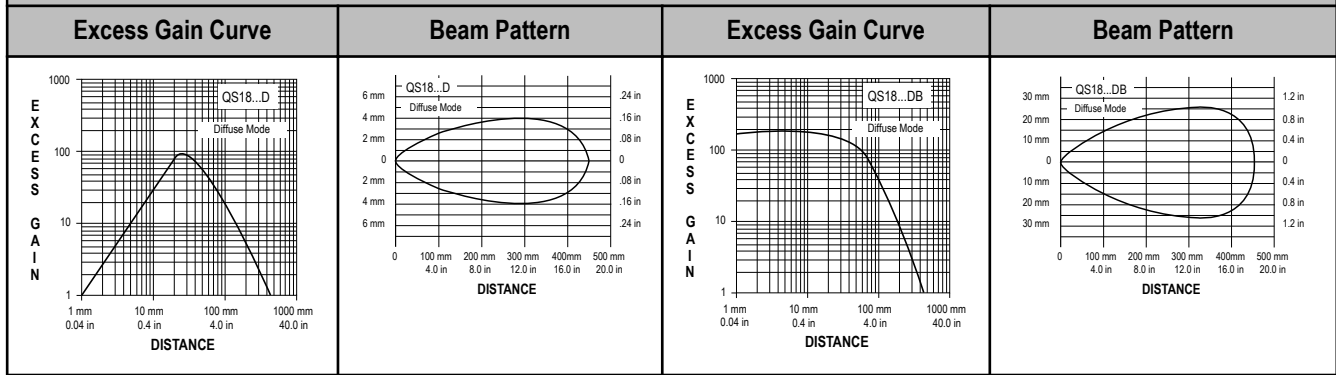

**Divergent (Performance is based on a 90% reflectance white test card.)**

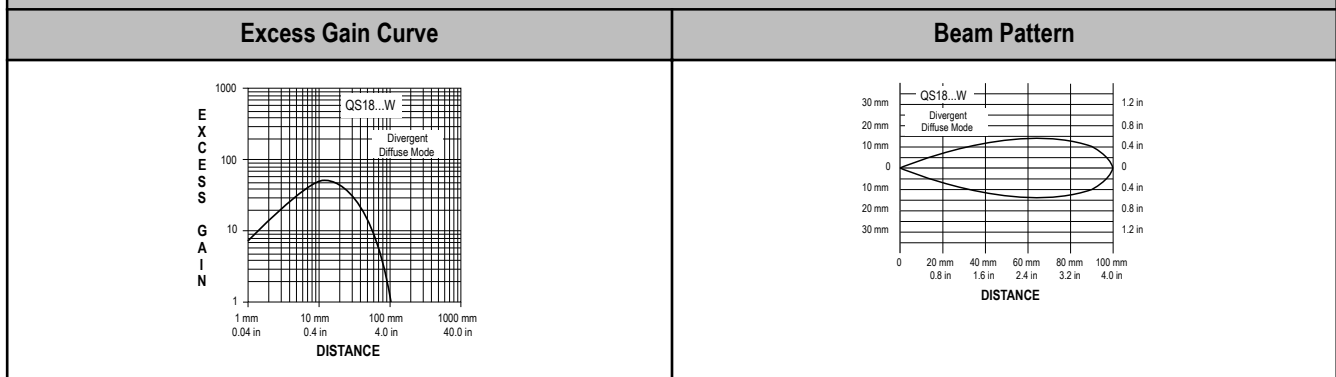

**Fixed Field - 50 mm**

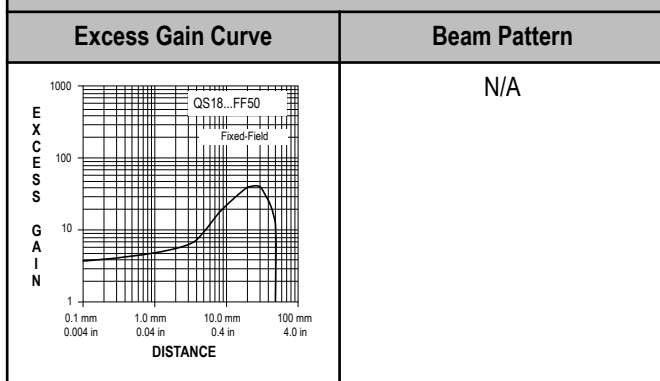

**Fixed Field - 100 mm**

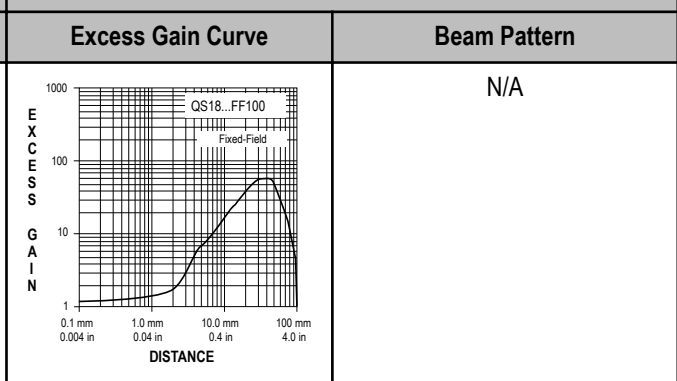

**Opposed - Plastic Fiber**

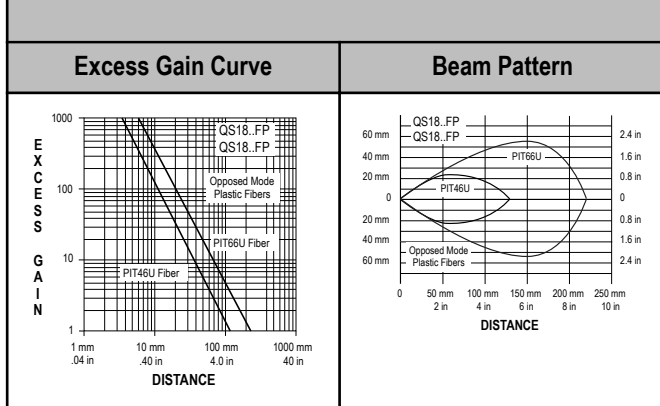

**Bifurcated - Plastic Fiber (Performance is based on a 90% reflectance white test card.)**

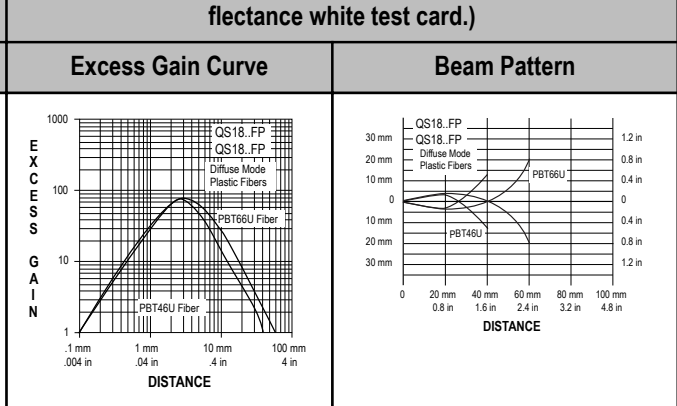

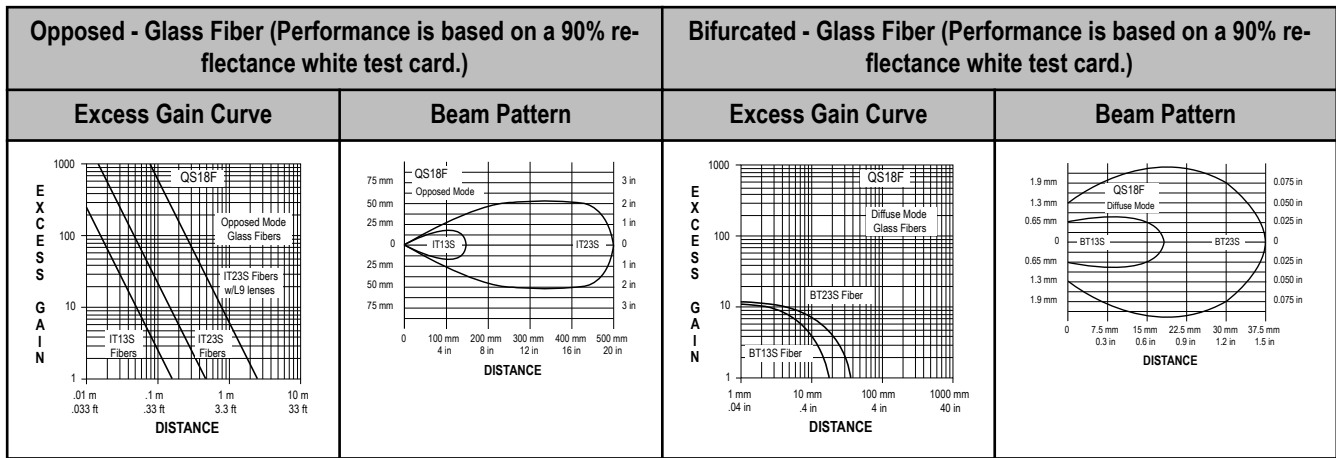

## Wiring Diagrams

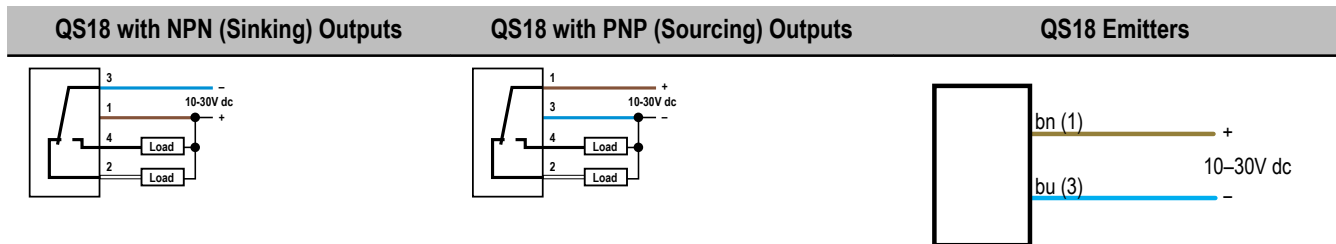

## Installing Fibers

### Cutting Underterminated Plastic Fibers

Underterminated plastic fibers are designed to be cut by the user to the length required for the application.

To facilitate cutting, a Banner model PFC-1 cutting device is supplied with the fiber. Cut the fiber as follows:

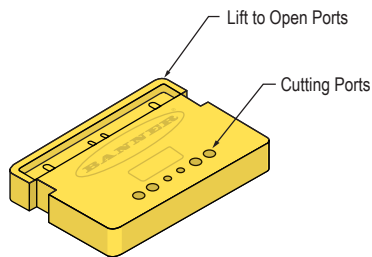

Use small ports for fiber sizes:

- 0.25 mm (0.01 inches)
- 0.5 mm (0.02 inches)

Use large ports for fiber sizes:

- 0.75 mm (0.03 inches)
- 1.0 mm (0.04 inches)
- 1.5 mm (0.06 inches)

1. Locate the “control end” of the fiber (the unfinished end).
2. Determine the length of fiber required for the application. If using a bifurcated fiber, separate the two halves of the fiber at least 2 inches beyond the fiber cutting location.
3. Lift the top (blade) of the cutter to open the cutting ports.
4. Insert one of the control ends through one of the cutting ports on the PFC-1 cutter so that the excess fiber protrudes from the back of the cutter.
5. Double-check the fiber length, and close the cutter until the fiber is cut.
6. Using a different cutting port, cut the second control end to the required length. To ensure a clean cut each time, do not use a cutting port more than once.
7. Gently wipe the cut ends of the fiber with a clean, dry cloth to remove any contamination. Do not use solvents or abrasives on any exposed optical fiber.

## Installing Plastic Fibers

Follow these steps to install the plastic fibers.

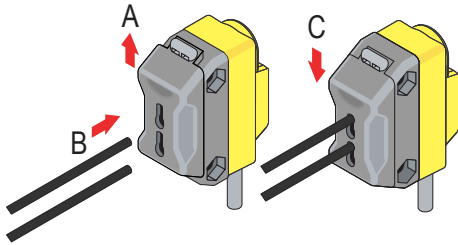

1. Unlock the fiber gripper as shown (A). When using 0.25 mm or 0.5 mm core fibers, slide the small fiber adapters onto the fibers, flush with the fiber ends.
2. Gently insert the prepared plastic fiber ends into the ports (B), as far as they will go.
3. Slide the fiber gripper back to lock (C).

## Installing Glass Fibers

Follow these steps to install the glass fibers.

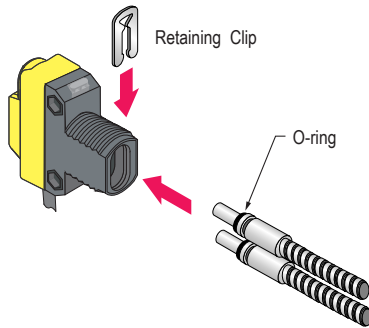

1. Install the O-ring (supplied with the fiber) on each end, as shown in the drawing.
2. Press the fiber ends firmly into the ports on the front of the sensor and slide the U-shaped retaining clip (supplied with the sensor) into the slot in the sensor's barrel until the clip snaps into place.



## Accessories

### Cordsets

4-Pin Threaded M12/Euro-Style Cordsets				
Model	Length	Style	Dimensions	Pinout
MQDC-406	1.83 m (6 ft)	Straight		
MQDC-415	4.57 m (15 ft)			
MQDC-430	9.14 m (30 ft)			
MQDC-450	15.2 m (50 ft)			
MQDC-406RA	1.83 m (6 ft)	Right-Angle		<p>1 = Brown 2 = White 3 = Blue 4 = Black</p>
MQDC-415RA	4.57 m (15 ft)			
MQDC-430RA	9.14 m (30 ft)			
MQDC-450RA	15.2 m (50 ft)			

4-Pin Snap-on M8/Pico-Style Cordsets				
Model	Length	Style	Dimensions	Pinout
PKG4-2	2.00 m (6.56 ft)	Straight		
PKW4Z-2	2.00 m (6.56 ft)	Right-Angle		

### WORLD-BEAM QS18 Brackets

All measurements are in millimeters.

<p><b>SMB18A</b></p> <ul style="list-style-type: none"> <li>• Right-angle mounting bracket with a curved slot for versatile orientation</li> <li>• 12-ga. stainless steel</li> <li>• 18 mm sensor mounting hole</li> <li>• Clearance for M4 (#8) hardware</li> </ul>	<p><b>SMB312S</b></p> <ul style="list-style-type: none"> <li>• Stainless steel 2-axis, side-mount bracket</li> </ul> <p>A = 4.3 x 7.5, B = diam. 3, C = 3 x 15.3</p>
--	--

**Hole center spacing:** A to B = 24.2  
**Hole size:** A =  $\varnothing$  4.6, B = 17.0 × 4.6, C =  $\varnothing$  18.5

### **Retroreflective Targets**

See the Accessories section of your current Banner Engineering Corp catalog for complete information. NOTE: Polarized sensors require corner cube type retroreflective targets only.

### **Plastic and Glass Fiber Optics**

See the Accessories section of your current Banner Engineering Corp catalog for a list of plastic and glass fiber optic cables.

## **Banner Engineering Corp Limited Warranty**

Banner Engineering Corp. warrants its products to be free from defects in material and workmanship for one year following the date of shipment. Banner Engineering Corp. will repair or replace, free of charge, any product of its manufacture which, at the time it is returned to the factory, is found to have been defective during the warranty period. This warranty does not cover damage or liability for misuse, abuse, or the improper application or installation of the Banner product.

**THIS LIMITED WARRANTY IS EXCLUSIVE AND IN LIEU OF ALL OTHER WARRANTIES WHETHER EXPRESS OR IMPLIED (INCLUDING, WITHOUT LIMITATION, ANY WARRANTY OF MERCHANTABILITY OR FITNESS FOR A PARTICULAR PURPOSE), AND WHETHER ARISING UNDER COURSE OF PERFORMANCE, COURSE OF DEALING OR TRADE USAGE.**

This Warranty is exclusive and limited to repair or, at the discretion of Banner Engineering Corp., replacement. **IN NO EVENT SHALL BANNER ENGINEERING CORP. BE LIABLE TO BUYER OR ANY OTHER PERSON OR ENTITY FOR ANY EXTRA COSTS, EXPENSES, LOSSES, LOSS OF PROFITS, OR ANY INCIDENTAL, CONSEQUENTIAL OR SPECIAL DAMAGES RESULTING FROM ANY PRODUCT DEFECT OR FROM THE USE OR INABILITY TO USE THE PRODUCT, WHETHER ARISING IN CONTRACT OR WARRANTY, STATUTE, TORT, STRICT LIABILITY, NEGLIGENCE, OR OTHERWISE.**

Banner Engineering Corp. reserves the right to change, modify or improve the design of the product without assuming any obligations or liabilities relating to any product previously manufactured by Banner Engineering Corp.



more sensors, more solutions

www.bannerengineering.com - tel: 763-544-3164