

Datasheet

Compact, Self-Contained Family of Sensors



- Photoelectric sensors in a compact, rugged, sealed, over-molded plastic housing
- Standard 3 mm threaded mounting holes on 25.4 mm (1 in) spacing
- Advanced electronic design for excellent noise immunity and cross-talk avoidance
- Threaded metal M8 connector on Pico-style quick-disconnect models
- 10 V dc to 30 V dc operation with complementary solid-state outputs (1 normally open, 1 normally closed); PNP or NPN, depending on model
- Complete offering of mounting brackets and apertures available
- Crosstalk prevention filters available for visible red opposed mode pairs
- Exceptional optical performance with easy to align visible red emitters
- Background suppression models provide reliable detection up to 150 mm while ignoring objects in the background
- Background suppression models provide stable detection in the presence of fluorescent lights



WARNING: Not To Be Used for Personnel Protection

Never use this device as a sensing device for personnel protection. Doing so could lead to serious injury or death. This device does not include the self-checking redundant circuitry necessary to allow its use in personnel safety applications. A sensor failure or malfunction can cause either an energized or de-energized sensor output condition.

Models

Model ¹	Sensing Mode	Range	Output ²
Q20E	Opposed, 624 nm Visible Red Effective Beam: 10 mm (0.4 in)	12 m (39.4 ft)	N/A
Q20PR			PNP
Q20NR			NPN
Q20EL	Opposed, 850 nm Infrared Effective Beam: 10 mm (0.4 in)	20 m (65.6 ft)	N/A
Q20PRL			PNP
Q20NRL			NPN
Q20PLP	Polarized Retroreflective, 660 nm Visible Red	4 m (13 ft) (specified using reflector BRT-84)	PNP
Q20NLP			NPN
Q20PLV	Retroreflective, 660 nm Visible Red	6 m (20 ft) (specified using reflector BRT-84)	PNP
Q20NLV			NPN

Diffuse-mode and fixed-field performances are based on the use of a 90% reflectance white test card.

Model ¹	Sensing Mode	Range	Output ²
Q20PDL	Long-Range Diffuse, 624 nm Visible Red	800 mm (32 in)	PNP
Q20NDL			NPN
Q20PDXL	Long-Range Diffuse, 850 nm Infrared	1500 mm (59 in)	PNP
Q20NDXL			NPN
Q20PD	Diffuse, 624 nm Visible Red	250 mm (10 in)	PNP
Q20ND			NPN
Q20PFF50	Fixed Field, 655 nm Visible Red	50 mm (2 in) cutoff	PNP
Q20NFF50			NPN
Q20PFF100		100 mm (4 in) cutoff	PNP
Q20NFF100			NPN
Q20PFF150		150 mm (6 in) cutoff	PNP
Q20NFF150			NPN

¹ Integral 2 m (6.5 ft) unterminated cable models are listed.

- To order the 9 m (30 ft) PVC cable model, add the suffix "W/30" to the cabled model number. For example, Q20E W/30.
- To order the 4-pin M8/Pico-style integral quick disconnect model, add the suffix "Q7" to the model number. For example, Q20EQ7.
- To order the 150 mm (6 in) PVC cable model with a 4-pin M8/Pico-style quick disconnect, add the suffix "Q" to the model number. For example, Q20EQ.
- To order the 150 mm (6 in) PVC cable model with a 4-pin M12/Euro-style quick disconnect, add the suffix "Q5" to the model number. For example, Q20EQ5.
- To order the 150 mm (6 in) PUR cable model with a 4-pin M12/Euro-style quick disconnect, add the suffix "QPMA" to the model number. For example, Q20EQPMA.
- Models with a quick disconnect require a mating cordset.

² Available with Health or Alarm Mode output; contact Banner Engineering for details.



Overview

Banner's Q20 family of sensors offers a full complement of sensing modes, with the excellent performance expected of much larger sensors. Their compact plastic housings feature overmolded construction for superior robustness and sealing. Their popular rectangular design is easy to mount into tight spaces; integral threaded mounting holes eliminate the need for separate mounting nuts.

The single-turn Gain potentiometer on most models and bright LEDs (positioned on top of the housing for 360° visibility) provide easy alignment and configuration for reliable sensing (see [Figure 1](#) on page 2).



(varies with model)

1. Output LED
2. Power LED
3. Single-Turn Gain Potentiometer (Retro and Diffuse models only)

Figure 1. Features

Wiring Diagrams

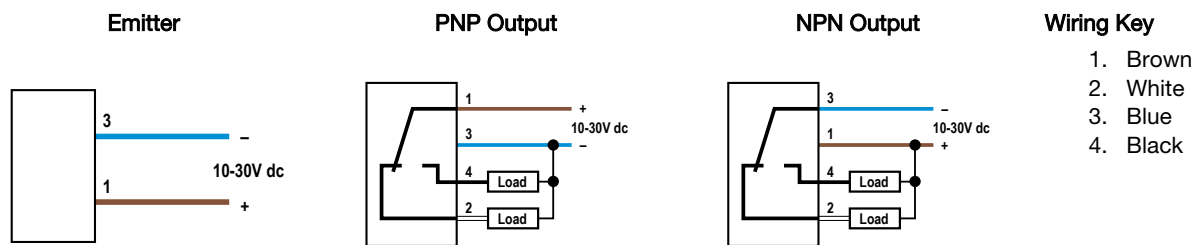

Cabled wiring diagrams are shown. Quick disconnect (QD) wiring diagrams are functionally identical.

Specifications

Supply Voltage

Fixed-Field: 10 to 30V dc (10% maximum ripple within specified limits) at less than 25 mA, exclusive of load
All others: 10 to 30V dc (10% maximum ripple within specified limits) at less than 18 mA, exclusive of load

Supply Protection Circuitry

Protected against reverse polarity and transient voltages

Output Configuration

100 mA with short circuit protection
 OFF-state leakage current: **NPN:** < 200 μ A sinking (see Application Note 2);
PNP: < 10 μ A sourcing
 ON-state saturation voltage: **NPN:** < 1.6V @ 100 mA; **PNP:** < 3.0V @ 100 mA

Output Configuration for LP and LV Models

PNP Output Voltage
 High $\geq V_{supply} - V_{saturation}$
 Low $\leq 1 V (\leq 1M \Omega)$
NPN Output Voltage
 High $\geq V_{supply} - 1 V (\leq 1M \Omega)$
 Low $\leq V_{saturation}$
 $V_{saturation} \leq 3 V$
 Max. Current $\leq 100 mA$

Output Response Time

Opposed Mode: 1 millisecond ON/600 microseconds OFF
Fixed-Field: 3 milliseconds ON/1.5 milliseconds OFF
All others: 800 microseconds ON/OFF
 100 millisecond delay on power-up; outputs do not conduct during this time

Repeatability

Opposed Mode: 140 microseconds
Fixed-Field: 182 microseconds
All others: 155 microseconds

Construction

ABS housing; PMMA lenses; PBT Gain Adjuster (Retro and Diffuse models only)

Connections

2 m (6.5 ft) or 9 m (30 ft) 4-wire PVC cable, 150 mm (6 in) pigtail with 4-pin threaded Pico-style (Q) or Euro-style (Q5) connector, or 4-pin integral threaded Pico-style connector (Q7), depending on model

Indicators

Two LED Indicators: Power (green) and Output (yellow)

Fixed-Field models:

Green ON Steady: Power ON
 Yellow ON Steady: Black (LO) wire conducting

All other models:

Green ON Steady: Power ON
 Green flashing: Output overloaded (varies with model)
 Yellow ON steady: Black (LO) wire conducting
 Yellow flashing: Marginal excess gain (1 to 1.5X)
 Black (LO) wire conducting

Adjustments

Diffuse, Retroreflective, and Polarized Retroreflective models (only):
 Single-turn Sensitivity (Gain) adjustment potentiometer

Applications Notes

1. Opposed mode sensor spacing can be reduced by alternating emitters and receivers or by applying cross talk filters (visible red models only)
2. NPN off-state leakage current is <200 µA for load resistances > 3kΩ or optically isolated loads. For load currents of 100 mA, leakage is <1% of load current.

Operating Conditions

-20 °C to +60 °C (-4 °F to +140 °F)
 95% at +50 °C maximum relative humidity (non-condensing)

Environmental Rating

IEC IP67 (NEMA 6)
 PW12 1200 PSI washdown

Vibration and Mechanical Shock

All models meet Mil. Std. 202F requirements method 201A (vibration: 10 to 60 Hz max., double amplitude 0.06", maximum acceleration 10G). Also meets IEC 947-5-2; 30G 11 ms duration, half sine wave

Certifications



(Class 2 power supply required)

Required Overcurrent Protection



WARNING: Electrical connections must be made by qualified personnel in accordance with local and national electrical codes and regulations.

Overcurrent protection is required to be provided by end product application per the supplied table.
 Overcurrent protection may be provided with external fusing or via Current Limiting, Class 2 Power Supply.
 Supply wiring leads < 24 AWG shall not be spliced.
 For additional product support, go to www.bannerengineering.com.

Supply Wiring (AWG)	Required Overcurrent Protection (Amps)
20	5.0
22	3.0
24	2.0
26	1.0
28	0.8
30	0.5

Performance Curves

Opposed Mode Models

Excess Gain

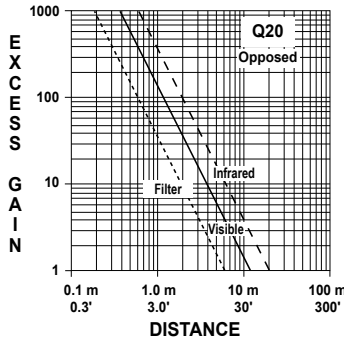

Beam Pattern

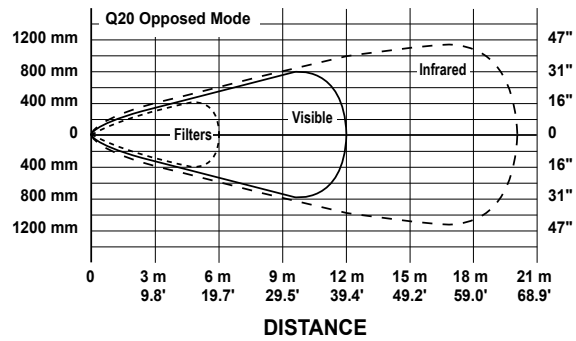

Retroreflective Mode Models (based on retroreflector BRT-84)

Excess Gain

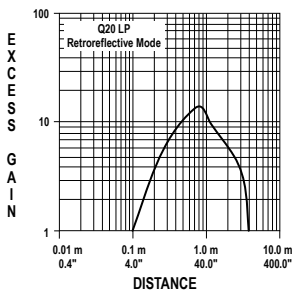

Beam Pattern

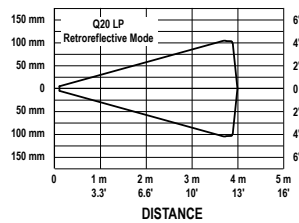

Excess Gain

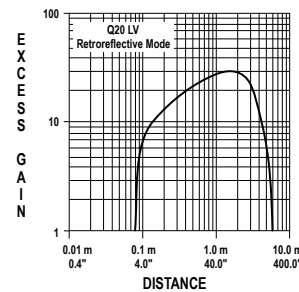

Beam Pattern

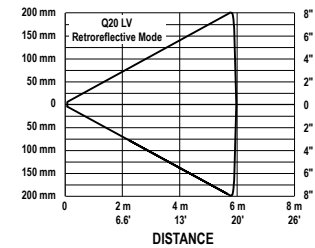

Diffuse Mode Models (based on 90% reflectance white test card)

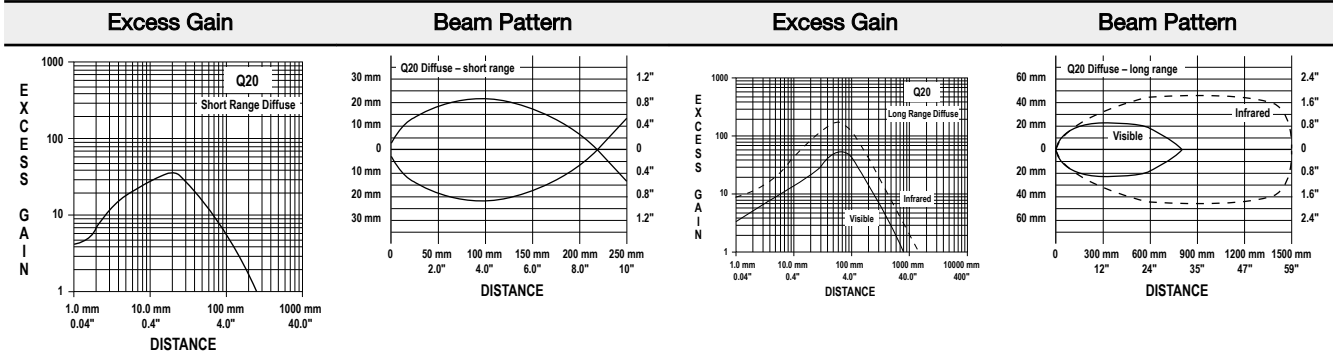

Fixed-Field Excess Gain (based on 90% reflectance white test card)

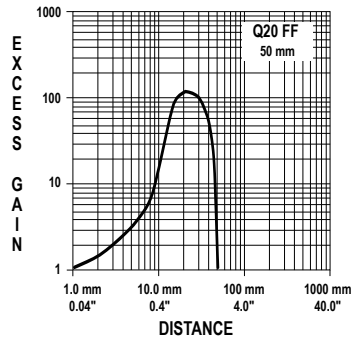

Ø 6 mm spot size at 25 mm
 Ø 6 mm spot size at 50 mm cutoff
Using 18% gray test card: cutoff distance will be 95% of value shown
Using 6% black test card: cutoff distance will be 90% of value shown

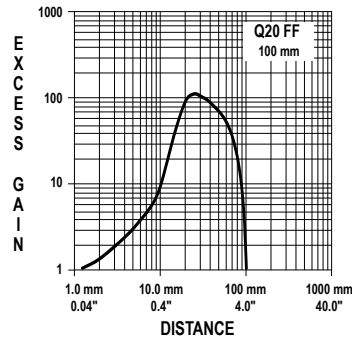

Ø 6 mm spot size at 50 mm
 Ø 6 mm spot size at 100 mm cutoff
Using 18% gray test card: cutoff distance will be 90% of value shown
Using 6% black test card: cutoff distance will be 85% of value shown

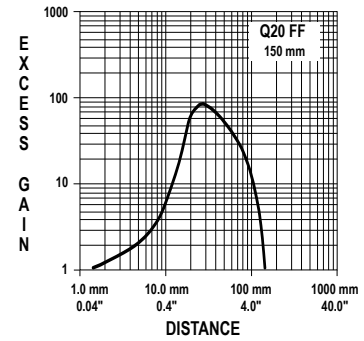

Ø 6 mm spot size at 75 mm
 Ø 9 mm spot size at 150 mm cutoff
Using 18% gray test card: cutoff distance will be 80% of value shown
Using 6% black test card: cutoff distance will be 70% of value shown

See [Accessories](#) on page 5, the Accessories section of the current Banner catalog, or www.bannerengineering.com for complete information.



Note: Polarized sensors require corner cube type retroreflective targets only.

Dimensions

Cabled and Pigtail QD Models

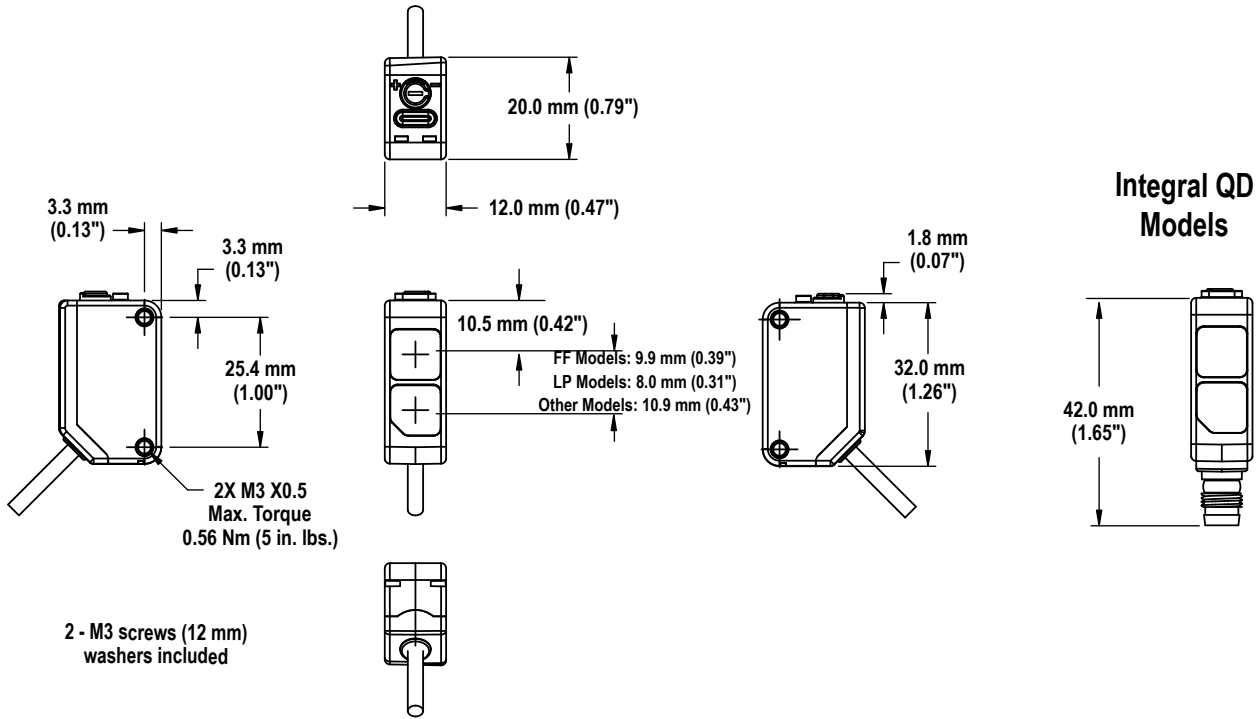

Accessories

Quick-Disconnect (QD) Cordsets

4-Pin Threaded M12/Euro-Style Cordsets				
Model	Length	Style	Dimensions	Pinout (Female)
MQDC-406	1.83 m (6 ft)	Straight		<p>1 = Brown 2 = White 3 = Blue 4 = Black</p>
MQDC-415	4.57 m (15 ft)			
MQDC-430	9.14 m (30 ft)			
MQDC-450	15.2 m (50 ft)			
MQDC-406RA	1.83 m (6 ft)	Right-Angle		
MQDC-415RA	4.57 m (15 ft)			
MQDC-430RA	9.14 m (30 ft)			
MQDC-450RA	15.2 m (50 ft)			

4-Pin Snap-on M8/Pico-Style Cordsets				
Model	Length	Style	Dimensions	Pinout (Female)
PKG4-2	2 m (6.56 ft)	Straight		<p>1 = Brown 2 = White 3 = Blue 4 = Black</p>
PKW4Z-2	2 m (6.56 ft)	Right-Angle		

4-Pin Threaded M8/Pico-Style Cordsets				
Model	Length	Style	Dimensions	Pinout (Female)
PKG4M-2	2 m (6.56 ft)	Straight		<p>1 = Brown 2 = White 3 = Blue 4 = Black</p>
PKG4M-5	5 m (16.4 ft)			
PKG4M-9	9 m (29.5 ft)			
PKW4M-2	2 m (6.56 ft)	Right Angle		
PKW4M-5	5 m (16.4 ft)			
PKW4M-9	9 m (29.5 ft)			

Mounting Brackets

SMBQ20L

- Sensor vertical base mount
- ±5° tip, ±7° swivel
- Stainless steel

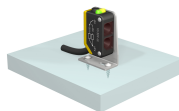

SMBQ20LV

- Sensor vertical back mount
- ±10° tip
- Stainless steel



SMBQ20H

- Sensor horizontal flange mount
- ±10° swivel
- Stainless steel

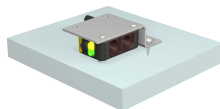

SMBQ20U

- Sensor vertical base mount with protection
- ±22.5° swivel
- Stainless steel

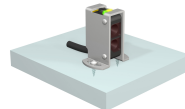

Cross Talk Prevention Filters

Model ³	Description	Reduced Sensor Range E/R (two apertures used)
PFQ20-H	 Stainless steel (natural color)	7.5 mm (0.3 in) dia.
PFQ20-V		
		6.0 m (21.3 in)

Apertures

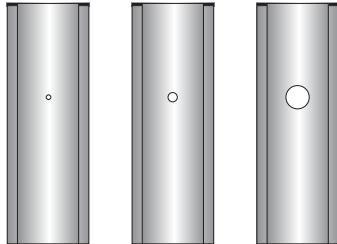
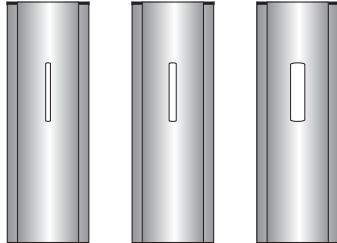
Model		Reduced Sensor Range E/R (two apertures used)	Reduced Sensor Range EL/RL (two apertures used)	Description	
Circular					
APQ20-0.5	0.5 mm (0.02") dia.	0.10 m (0.33 ft)	0.18 m (0.6 ft)		
APQ20-1	1 mm (0.04") dia.	0.35 m (1.14 ft)	0.66 m (2.1 ft)		
APQ20-2	2 mm (0.08") dia.	1.5 m (4.9 ft)	2.9 m (9.5 ft)		
Vertical Slot					
APQ20-0.5V	0.5 mm (0.02") dia.	1.4 m (4.6 ft)	2.3 m (7.5 ft)		
APQ20-1V	1 mm (0.04") dia.	2.8 m (9.2 ft)	4.8 m (15.7 ft)		
APQ20-2V	2 mm (0.08") dia.	5.8 m (19.0 ft)	8.6 m (28.2 ft)		
APK-Q20	Includes two of each type				

Banner Engineering Corp. Limited Warranty

Banner Engineering Corp. warrants its products to be free from defects in material and workmanship for one year following the date of shipment. Banner Engineering Corp. will repair or replace, free of charge, any product of its manufacture which, at the time it is returned to the factory, is found to have been defective during the warranty period. This warranty does not cover damage or liability for misuse, abuse, or the improper application or installation of the Banner product.

THIS LIMITED WARRANTY IS EXCLUSIVE AND IN LIEU OF ALL OTHER WARRANTIES WHETHER EXPRESS OR IMPLIED (INCLUDING, WITHOUT LIMITATION, ANY WARRANTY OF MERCHANTABILITY OR FITNESS FOR A PARTICULAR PURPOSE), AND WHETHER ARISING UNDER COURSE OF PERFORMANCE, COURSE OF DEALING OR TRADE USAGE.

This Warranty is exclusive and limited to repair or, at the discretion of Banner Engineering Corp., replacement. **IN NO EVENT SHALL BANNER ENGINEERING CORP. BE LIABLE TO BUYER OR ANY OTHER PERSON OR ENTITY FOR ANY EXTRA COSTS, EXPENSES, LOSSES, LOSS OF PROFITS, OR ANY INCIDENTAL, CONSEQUENTIAL OR SPECIAL DAMAGES RESULTING FROM ANY PRODUCT DEFECT OR FROM THE USE OR INABILITY TO USE THE PRODUCT, WHETHER ARISING IN CONTRACT OR WARRANTY, STATUTE, TORT, STRICT LIABILITY, NEGLIGENCE, OR OTHERWISE.**

Banner Engineering Corp. reserves the right to change, modify or improve the design of the product without assuming any obligations or liabilities relating to any product previously manufactured by Banner Engineering Corp. Any misuse, abuse, or improper application or installation of this product or use of the product for personal protection applications when the product is identified as not intended for such purposes will void the product warranty. Any modifications to this product without prior express approval by Banner Engineering Corp will void the product warranties. All specifications published in this document are subject to change; Banner reserves the right to modify product specifications or update documentation at any time. Specifications and product information in English supersede that which is provided in any other language. For the most recent version of any documentation, refer to: www.bannerengineering.com.

³ For visible red models only. The "H" and "V" in the model numbers refer to the polarization of the filter material. Since they are visually identical, the "H" models have been left the natural stainless steel and the "V" models have been colored black.